



SAP

Basis

tutorialspoint

S I M P L Y E A S Y L E A R N I N G

www.tutorialspoint.com



<https://www.facebook.com/tutorialspointindia>



<https://twitter.com/tutorialspoint>

About the Tutorial

SAP Basis refers to the administration of SAP system that includes activities like installation and configuration, load balancing, and performance of SAP applications running on Java stack and SAP ABAP. This includes the maintenance of different services related to database, operating system, application and web servers in SAP system landscape and stopping and starting the system.

This tutorial will walk you through the different features of SAP Basis.

Audience

This tutorial is designed for all those readers who are willing to learn SAP Basis administration in simple and easy steps.

Prerequisites

The course is designed for beginners with little or no SAP Basis experience. But you need to have a basic understanding of SAP basics to make the most of this tutorial.

Disclaimer & Copyright

© Copyright 2018 by Tutorials Point (I) Pvt. Ltd.

All the content and graphics published in this e-book are the property of Tutorials Point (I) Pvt. Ltd. The user of this e-book is prohibited to reuse, retain, copy, distribute or republish any contents or a part of contents of this e-book in any manner without written consent of the publisher.

We strive to update the contents of our website and tutorials as timely and as precisely as possible, however, the contents may contain inaccuracies or errors. Tutorials Point (I) Pvt. Ltd. provides no guarantee regarding the accuracy, timeliness or completeness of our website or its contents including this tutorial. If you discover any errors on our website or in this tutorial, please notify us at contact@tutorialspoint.com.

Table of Contents

	About the Tutorial	i
	Audience	i
	Prerequisites	i
	Disclaimer & Copyright	i
	Table of Contents	ii
1.	SAP BASIS — OVERVIEW	1
	Transaction Codes	3
2.	SAP BASIS — INSTALLATION OF SAP GUI.....	4
	Advanced Features in SAP GUI	4
	Supported Available Versions for Different Platforms	4
	Microsoft Windows Release	5
	JAVA Release	5
	Support Lifecycle	7
3.	SAP BASIS — SAP GUI SELECTION.....	9
	SAP Instance and SID	9
	SAP System Number	12
4.	SAP BASIS — SYSTEM LANDSCAPE & ARCHITECTURE.....	13
	SAP System 3 – Tier Architecture.....	14
5.	SAP BASIS – HARDWARE & SOFTWARE INSTALLATION.....	16
	Installation of SAP ECC 6.0.....	17
	Different Hardware and Software Components in SAP System.....	21
6.	SAP BASIS — NW SYSTEM	25

7.	SAP BASIS — NW ARCHITECTURE.....	27
	Installation Options for SAP NetWeaver	28
	Application Center and Instances	28
	Managing Java Instances using NWA	29
	SAP NW System Landscape.....	30
	System Landscape Management using SAP Solution Manager	30
	Verifying Landscape with SAP Solution Manager.....	30
8.	SAP BASIS — SAP CLIENT ADMINISTRATION	32
	Advantages of Client Concept.....	32
	Steps to Create a New Client in SAP.....	32
9.	SAP BASIS — USER ACTIVITIES	41
	Creating a User	41
10.	SAP BASIS — NUMBER OF LOGIN ATTEMPTS.....	48
	Password Policy.....	50
	Limit Users on Password Selection	50
11.	SAP BASIS — JOB PROCESSING.....	52
	Executing Background Jobs in SAP	52
12.	SAP BASIS — UNSCHEDULING A BACKGROUND JOB	56
13.	SAP BASIS — MONITORING A BACKGROUND JOB.....	58
14.	SAP BASIS — DELETING A BACKGROUND JOB	61
15.	SAP BASIS — MANAGING TRANSPORTS	64
	Transport Management System Overview (TMS)	64
	Configuring Transport Management.....	64

16.	SAP BASIS — MANAGING TRANSPORT ROUTES	67
	Transport Request	67
	Import / Export of Objects	69
	Transport Request logs	70
17.	SAP BASIS — PATCH MANAGEMENT	71
	Support Packages and Add-ons	71
	Requirements to Implement Support Package	72
18.	SAP BASIS — IMPORTING A QUEUE	76
19.	SAP BASIS — KERNEL UPGRADE AND PATCHING.....	80
20.	SAP BASIS — SYSTEM MONITORING	87
21.	SAP BASIS — REMOTE FUNCTION CALL.....	91
	What is RFC?	91
22.	SAP BASIS – RFC BETWEEN SAP ECC & HANA.....	93
	Creating a Trusted RFC between SAP ECC and HANA	93
	Configuring RFC Connection	95
	Testing Trusted RFC	96
23.	SAP BASIS — NEW DIMENSIONAL PRODUCT.....	97
	Introduction to BI / BW	97
	Basis Integration with ECC	98
24.	SAP BASIS — INTERVIEW QUESTIONS	100

1. SAP Basis — Overview

SAP Basis refers to the administration of SAP system that includes activities like installation and configuration, load balancing, and performance of SAP applications running on Java stack and SAP ABAP. This includes the maintenance of different services related to database, operating system, application and web servers in SAP system landscape and stopping and starting the system.

The key responsibilities of SAP Basis Administrator include:

- System installation and Configuration
- Load balancing on servers
- Performance management of different components
- Managing interfaces and integration with servers
- Managing servers and different services

With the help of SAP Basis, different SAP modules like Finance Accounting, Production Planning, Sales and Distribution, SAP EWM and other modules can integrate and communicate with each other.

SAP Basis supports the installation and configuration of SAP applications on different operating systems like Windows, Unix, AS/400, etc. and different databases like SQL Server, Oracle, IBM DB2 for back end database.

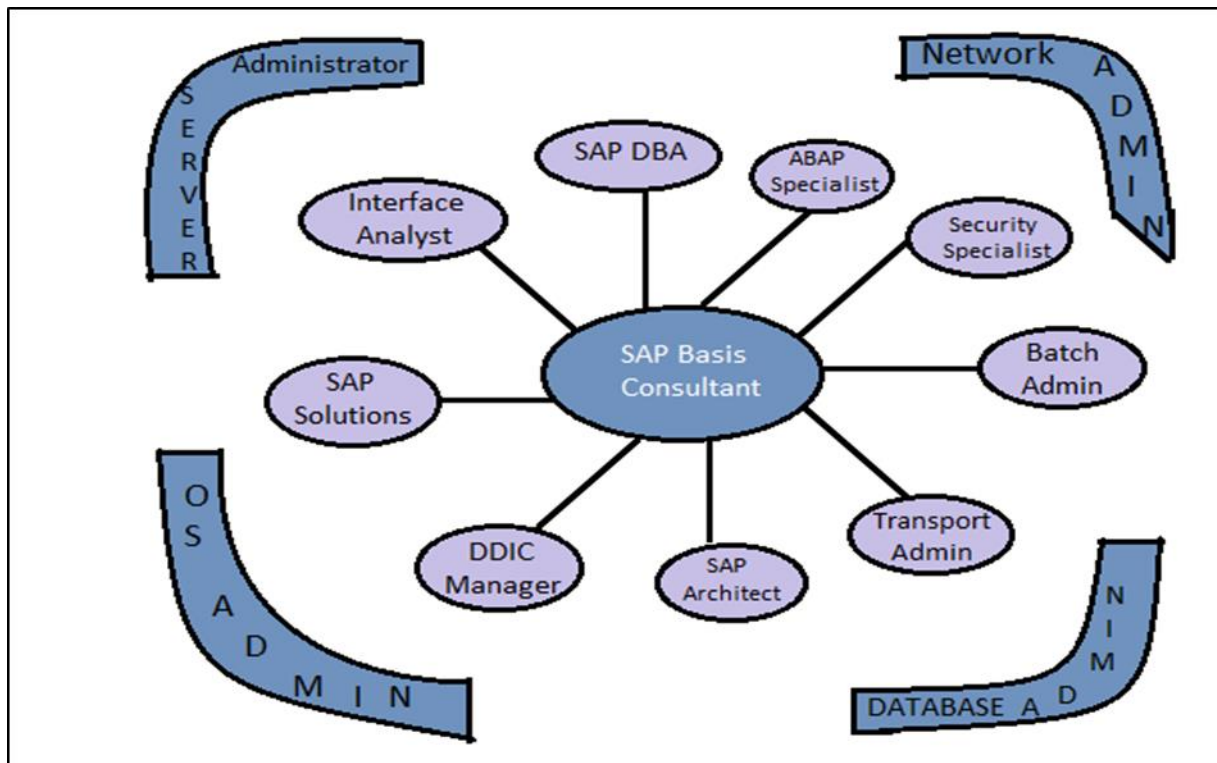

This picture defines the key activities that involve the role of SAP Basis Consultant. The roles of the SAP Basis Consultant are divided into the following categories:

Solution Specialist

The Solution Specialist is responsible for:

- Upgrading the SAP version of system landscape
- SAP Data backup archive
- Migration of Operating system and Database
- Installation of AP/Add On

Interface Analyst

The Interface Analyst is responsible for:

- Configuration and set up of interface between different modules

System Administrator

The System Administrator is responsible for:

- Monitoring the performance of SAP system and modules
- Maintaining SAP system health and performing health checkup

SAP Database Administrator

The SAP Database Administrator is responsible for:

- Backup and restoring the database of SAP system
- Managing database objects

Transport and Batch Job Administrator

The Transport and Batch Job Administrator is responsible for:

- Managing batch job scheduling and replication
- Managing SAP Control access in system landscape

DDIC Manager

The DDIC Manager is responsible for:

- Managing changes to Data Dictionary

SAP Architect

The SAP Architect is responsible for:

- Designing work and data flow in the SAP system
- Managing SAP sizing

SAP ABAP Specialist

The SAP ABAP Specialist is responsible for:

- Troubleshooting and tuning of ABAP Programs
- Applying correction to Programs as per SAP
- Coding and customization of ABAP program as per requirement

Transaction Codes

There are various Transaction Codes (T-codes) that a SAP Basis Administrator uses to perform the assigned tasks. The following is a list of important SAP Basis T-codes:

SM02 — To send messages to users who are logged in and new users logging to the client

SM01 — To take control of transaction codes. In case, the business requires that the users who are authorized to carry the transactions are to be stopped temporarily.

SM04 — To check the number of users who are logged into the system and in which client and how many sessions each user is generated and in each session what transaction is being executed.

SM13 — To keep track of the status of the Update service is Active, in case it is not active then we activate from the Update Administrator.

SM37 — To monitor the status of the jobs that are created by a user and for specific dates.

PFCG — This is used to maintain roles in SAP system.

SM21 — SAP system log is displayed for the values inputted in the initial screen. The values that can be maintained is the From Date.

RZ20 — This is used for cross system monitoring. In this transaction, we have a tree structure that performs a set of transactions and also keeps a track of all the alerts that were captured during the operation of the system

2. SAP Basis — Installation of SAP GUI

SAP GUI is a client tool which is used to access remote central server and runs on different operating systems like Microsoft Windows, UNIX, Mac, etc. This is used to manage and access SAP applications like SAP ECC and SAP Business Intelligence System.

Advanced Features in SAP GUI

The following are the advanced features of SAP GUI:

Blue Crystal design

SAP Blue Crystal is a new visual design theme which succeeds Corbu. It provides a consistent design that allows users to seamlessly experience SAP GUI and NWBC elements.

It is the standard theme of Fiori applications and comes with a new color palette and icons which are better scalable.

The background texture has a stroke pattern in white and light blue with a gradient layer.

As it replaces Corbu with Blue Crystal, this integrates SAP GUI for Windows 7.40 and NWBC 5.0

Complete icons redesign for Blue Crystal

All SAP GUI icons used by SAP applications have been redesigned and are now fitting the Blue Crystal Design. Additionally, they are much better scalable than before. The new set of icons is exclusive to Blue Crystal Design.

New default color for Blue Crystal icons

When you use it with patch 2, the main color changes from blue to dark gray in order to harmonize the design with the Fiori Application design.

Supported Available Versions for Different Platforms

The following are the supported available versions for different platforms:

- SAP GUI for the Windows environment
- SAP GUI for the Java(TM) environment
- SAP GUI for HTML / Internet Transaction Server (ITS)

SAP GUI has been released separately for Windows and Java support and the latest version for Windows and Java is 7.4.

Microsoft Windows Release

SAP GUI 7.4, the latest version for Windows was released in October, 2014 and it supports various features like — it is by default installed with NWBC 5.0 and SAP GUI and GUI shortcuts are launched through NWBC.

However, you also have the possibility to use SAP GUI and NWBC in parallel. To do so, you merely have to select the new component **Install SAP GUI Desktop Icon/Shortcuts** to install the SAP Logon (Pad) Desktop Icon and to register SAP GUI shortcuts to SAP Logon.

JAVA Release

SAP GUI 7.4 is the latest version for JAVA. This provides support to other operating systems and was released in October, 2014. As SAP GUI for Java 7.40 is not available on DVD right now, you need to proceed to the patches section on the SAP Support Portal to download SAP GUI for Java 7.40.

Downloading SAP GUI from SAP Marketplace

The following are the steps to download SAP GUI from SAP Marketplace:

Step 1: To use SAP GUI for accessing remote central service, you have to first download it from SAP Market place.

Step 2: Go to- service.sap.com to login to SAP Market Place.

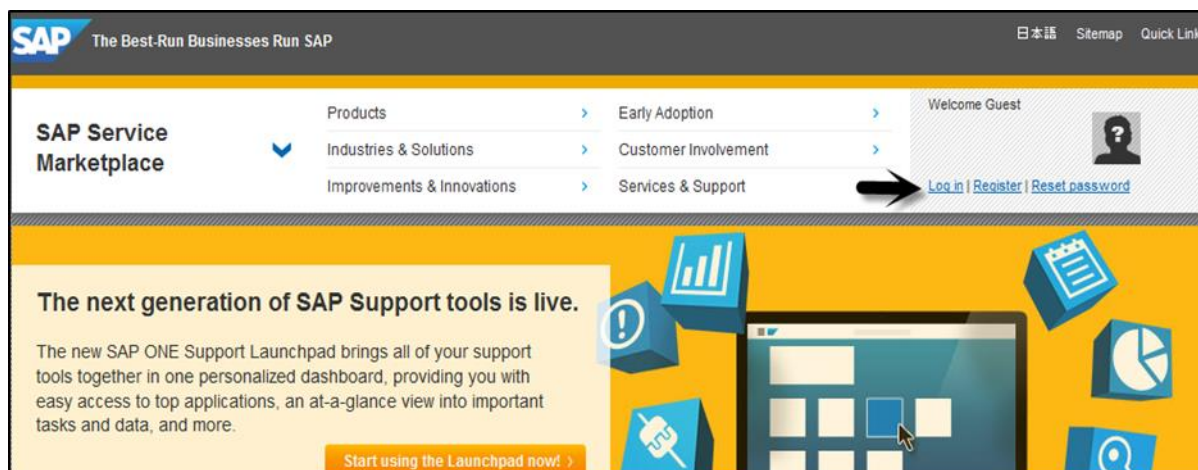

Step 3: Login using SID SXXXXXXXX and password. Once you login, go to Products > Software Downloads

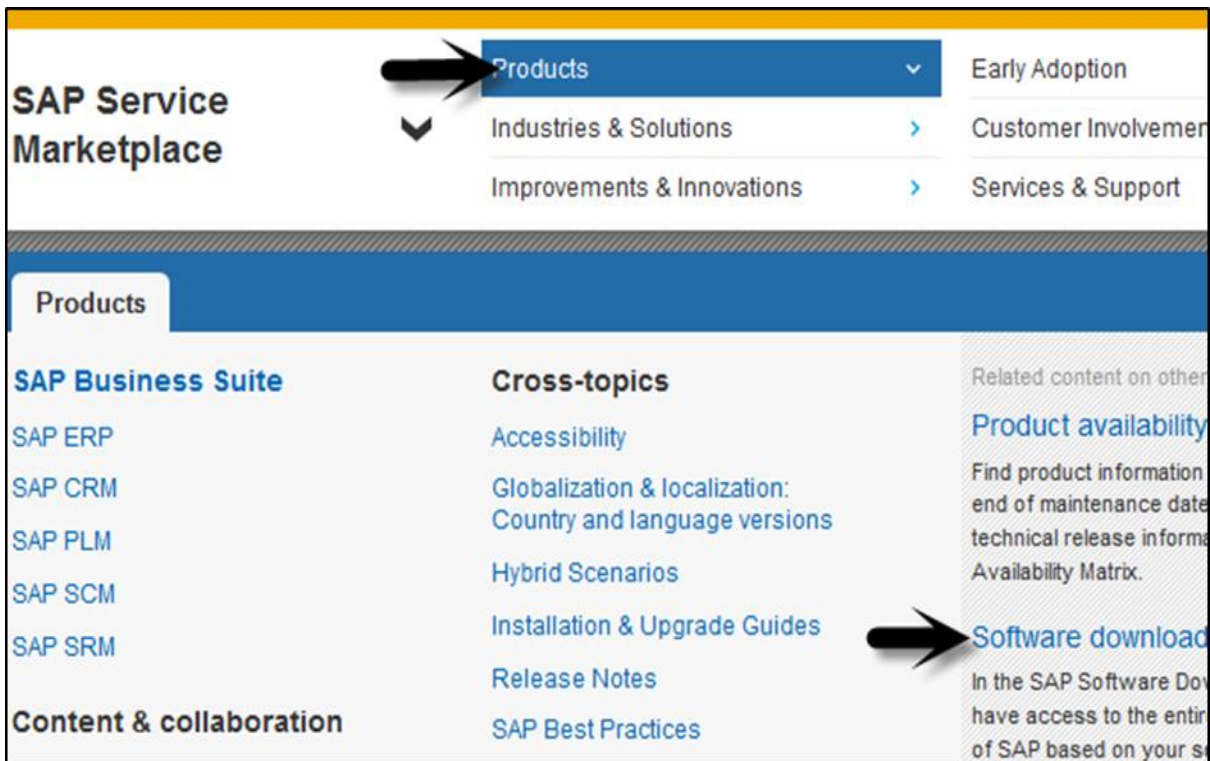

Step 4: Under Software downloads, go to Installation and upgrades. Follow the alphabetical order A-Z and select 'G' from list.

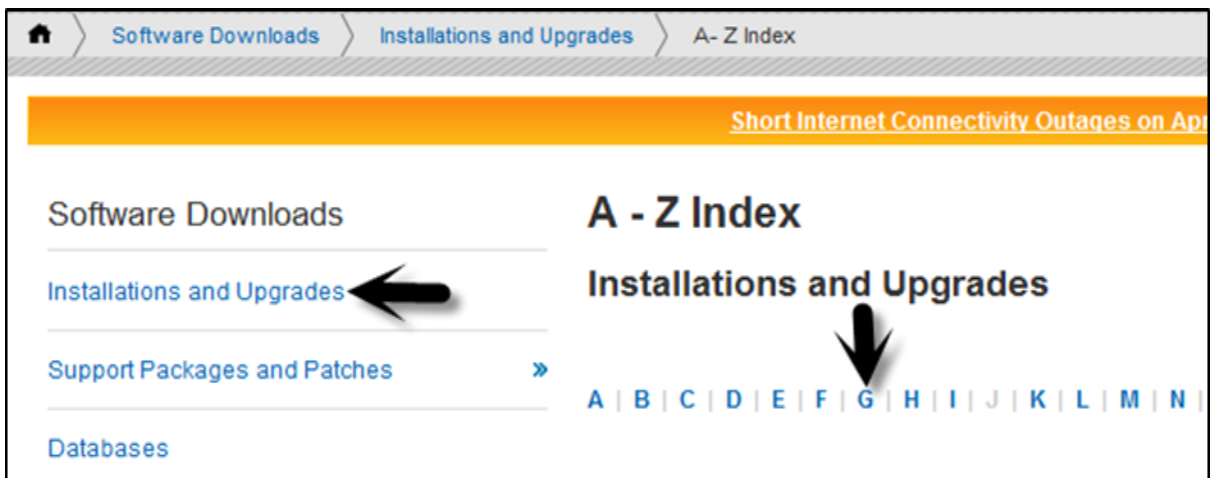

The screenshot shows a navigation bar with letters A through Z and 'All'. Below it, the heading 'INSTALLATIONS AND UPGRADES - G' is displayed in orange. A large black arrow points downwards towards a list of links. The links are arranged in two columns:

- Left column:
 - [SAP GRC Access Control](#)
 - [GSBA](#)
 - [GSTRBK](#)
- Right column:
 - [SAP GUI FOR JAVA](#)
 - [SAP GUI FOR WINDOWS](#)
 - [SAP GUI FOR WINDOWS FOR S/4](#)

Step 5: Select platform from the list available, you can select SAP GUI for Windows, SAP GUI for JAVA, and SAP GUI for Windows for S/4. Once you click there, you can see detailed information about all that is there in the latest version of SAP GUI — features, support lifecycle, dependencies, general information, etc. on Info Page.

Support Lifecycle

SAP GUI for Windows 7.40 was shipped in "General Availability" (released for productive usage) on 8th October, 2014. When planning a SAP GUI upgrade, please consider moving directly to release 7.40.

Please consider these end of support dates when planning or reviewing your frontend landscape:

- On 9th of April 2013 support for SAP GUI for Windows 7.20 ended.
- On 15th of July 2015 full support for SAP GUI for Windows 7.30 ended.
- On 31st of October 2015 restricted support for SAP GUI for Windows 7.30 will end.
- On 9th of January 2018 support for SAP GUI for Windows 7.40 will end.

Also consider, SAP Notes — 147519

Go to Download -> Select files to add to the download basket.

Downloads

SAP GUI FOR WINDOWS 7.40 CORE

Select one or more files and click "Add to download basket". We recommend that you use the [SAP](#) time.
Get more information about [multispanning and how to extract multi-part archives](#) . Click on  to

Add to Download Basket **Maintain Download Basket** **Select All** **Deselect All**

The following objects are available for download:

	File Type	Download Object	Title
<input type="checkbox"/>	ZIP	50127120_6	Presentation - 7.40 Compila

Add to Download Basket **Maintain Download Basket** **Select All** **Deselect All**

You can get it from the download basket later on. Save the file to the local system and run the setup. You can select to choose from different components-

SAP Front End Installer

SAP FRONT-END INSTALLER

SAP NetWeaver Business Client 5.0

SAP GUI for windows 7.40 (Compilation 1)

Install SAP GUI Desktop Icon / Shortcuts even th

Engineering Client Viewer 7.0

KW Add-On for SAP GUI 7.40

i.s.h.med Planning Grid

SAP Automatic Workstation Update

Business Explorer

SAP Interactive Excel 3.0.3

SAP JNet/JGantt

SAP CLI Cross-Desktop Substition for 3A11E

Select all Deselect all

SAP JNet/JGantt

SAP JNet/JGantt is an editor for network graphics that can be used by any application to integrate different forms of graphic representations. This component requires a 32-bit Java Runtime Environment (version 6u11 or higher or version 7u4 or higher) to be installed

Disk space usage
Total: 56 MB
On system drive: 21 MB

< Back **Next >** **Cancel**

Press Next > Finish the setup.

3. SAP Basis — SAP GUI Selection

As mentioned, there are three different GUIs available and we can select the right version based on the requirement. The following scenario can help you find a suitable SAP GUI:

When users are working rarely in the SAP system

Suppose most of the users fall in this category, then it is suggested to use SAP GUI for HTML format. This allows you to save effort and money for client deployment

When users are working mostly in the SAP system

In a case such as this, SAP GUI for Windows or SAP GUI for Java is recommended.

When users are ABAP developers

For ABAP developers, it is recommended that they use SAP GUI for Windows

When users use operating systems other than Microsoft

It is recommended they use SAP GUI for Java and HTML or they can use the SAP GUI for Windows on a remote server.

When users are integrating Dynpro transactions to the Portal

It is recommended they use SAP GUI for HTML. This allows you to integrate classic Dynpro-based applications into the portal easily.

SAP Instance and SID

A SAP instance is when you install and configure a SAP system. This instance defines a group of resources — memory, processors and other resources in the system. This allows users to login to the SAP system and share the same resources.

SAP instance is managed by CCMS. Users can login to the SAP system using an instance.

A SAP system can consist of one or more instances — you can set up a SAP system with a single instance with only one CCMS or you can configure a system with two or more separate instances in client/server environment.

Configuring a SAP instance

You need to follow these steps to configure a SAP instance:

Step 1: You need to define separate directories for UNIX, AS/400, or Microsoft Windows NT server on which the instance is to run.

Step 2: You can use a shared file system.

Step 3: For each instance, there are entries created in operating system configuration files (/etc/services, /etc/sapconfig...).

Step 4: There are communication entries created in the host.

Step 5: For each instance, start and system profiles are created.

Step 6: For each instance, operating system users are installed.

Creating an instance for one server

You need to follow these steps to create an instance for one server:

Step 1: To create an instance, you should first define the mode of operation.

Step 2: To create an instance, go to CCMS > Configuration or use Transaction code RZ04.

Step 3: Go to instances/operation modes as shown in shown in the screenshots below.

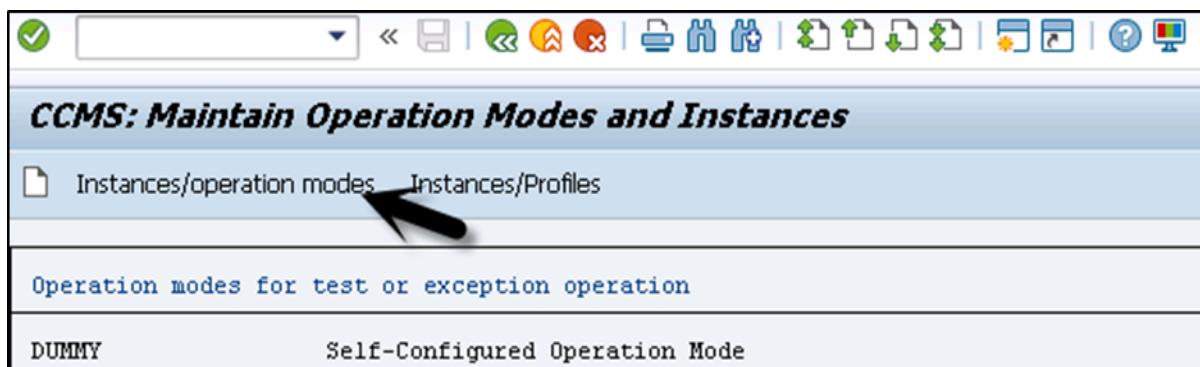
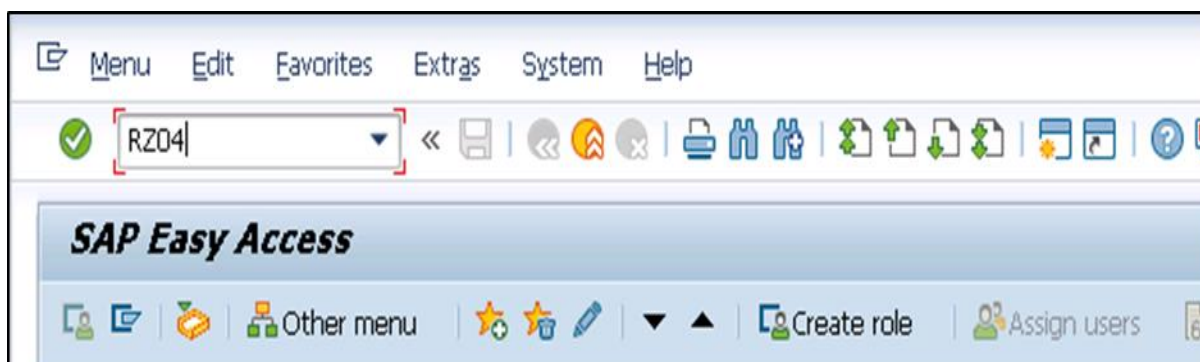

Step 4: To create a new instance, click on create new Instance — (F6) option as in the following screenshot:

CCMS: Maintain Operation Modes and Instances

Consistency check Profile view

Productive instances and their WP distribution

Host Name	Server Name	Instance Profile	Operation Mode	Dia	Res	BP	BPA	Spo	Upd	Up2	Enq	Su
-----------	-------------	------------------	----------------	-----	-----	----	-----	-----	-----	-----	-----	----

Step 5: Enter the host name and click on current settings. When application server is already running, the system will display the current settings for that instance.

Step 6: If the application server is not running, you should use the input help to display the possible entries and fill the below values.

Step 7: Enter the host name and choose current settings. If the application server is already running, the system will display the current settings for that instance. However, if the application server is not yet running, you should use the input help to display the possible entries and fill in the following fields:

CCMS: Maintain Instance Data

Current settings Maintain details Check profile

Installation data

Host Name

SAP system no.

Number of work processes

Config'able WPs

Max. Work Procs

Instance profile

Profile name

Display Change

Admin. user for start/stop

Admin User

Instance details

Appl. server

Instance Name

OS type

Home Directory

Instance Prof.

SAP System Number

The SAP System Number is the number that is mentioned when the SAP System is installed.

Start Profile: Profile Name

Insert the name of the start profile from Profiles to start the instance. You can also click on "choose the input help" to display a list of available start profiles. You can select a profile from the available list.

Instance Profile: Profile Name

You have to select the name of instance profile from Profiles to run the instance. You can click on "input help" to display a list of available instance profiles.

To save the instance, click on Save button at the top > Continue

Maintaining Instance Definition

When you define operation modes, you need to maintain instance definition. Follow these steps to change the definition:

Step 1: Use Transaction Code: RZ04

Step 2: Select Instances/operation mode

Step 3: Select an entry from the list of productive instances.

Step 4: You can then change the data for that instance.

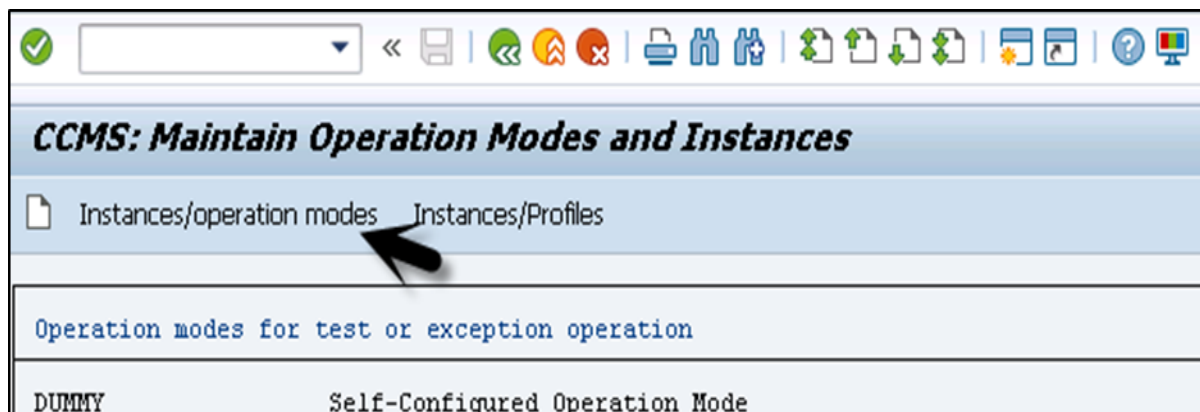

Step 5: You can also delete an instance, operation mode using the same transaction code.

Step 6: To delete an operation mode — From the list of productive operation modes, position the cursor on a line with the operation mode. Select operation mode > Delete. This deletes the operation mode, and all the instances and work process definitions assigned to it.

4. SAP Basis — System Landscape & Architecture

SAP system landscape is defined as an arrangement of SAP servers. Ideally, in a Sap environment, a three-system landscape exists. A system landscape consists of Development Server (Dev), Production Server (PROD), and Quality Assurance server (QAS).

SAP Architecture is defined as a technology framework of SAP system and it changes with time unlike the system landscape. SAP Architecture changes with new software like SAP ECC 6.0, the most recent one.

The following is a request in SAP System Landscape:

DEVELOPMENT >>>> Quality >>>> PRODUCTION

The following figure represents SAP three tier system landscape where work flows from Dev > QAS > PROD and not in backward direction.

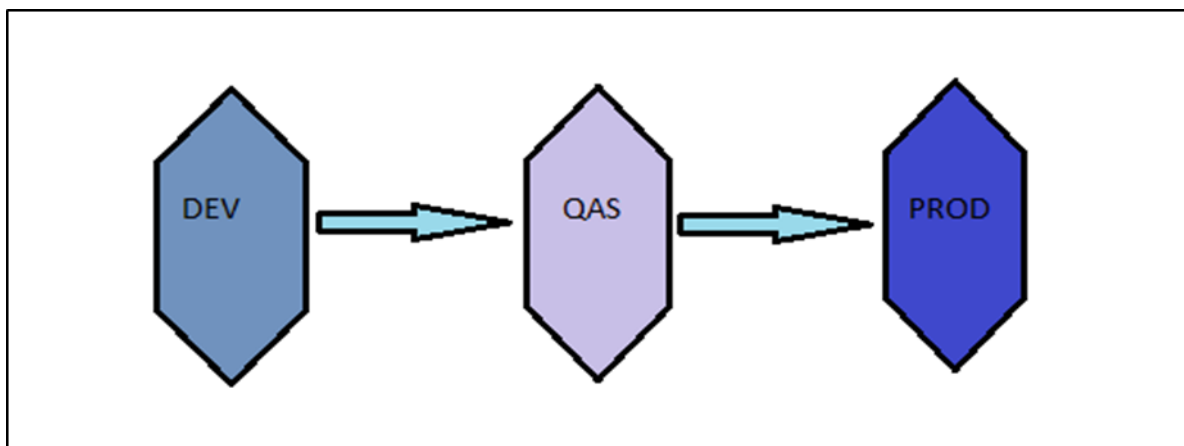

Let us now discuss the system landscape:

Sandbox Server

When a project is implemented, at the initial stages, a sandbox server is used where all the customization, configuration is performed.

Development Server

Next is to save the configuration in development server and saved in workbench requests and this has to be transported to Production server.

Production Server

You can consider it as the final or the most refined stage where the work is done when project is in production/go live. All the changes that are required by the client are performed in the DEV environment and later, the request is transported to production.

SAP System 3 – Tier Architecture

The image given below shows 3-tier architecture of the SAP system. The **presentation layer** is the topmost one. This contains the device/application to control the SAP system. This can include mobile devices, end user systems or SAP GUI or web browser based client.

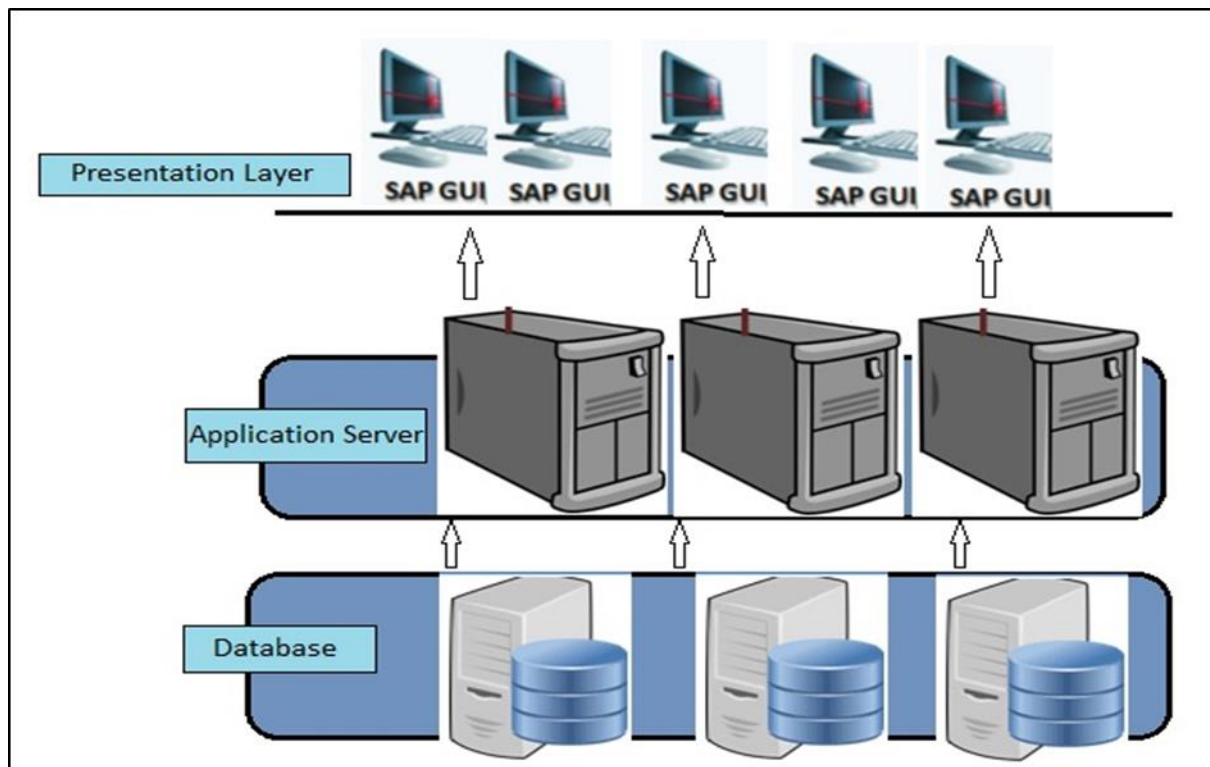

The presentation layer communicates with the application server to perform all the processing and which is known as brains of an SAP system.

An application server consists of multiple instances and communicates with the database layer of the three-tier architecture.

The bottom layer is called the **database layer**. This is responsible to store all the data. The database of SAP system is kept on a separate server for performance and security reasons.

The presentation layer consists of different components for ABAP and JAVA that enables the communication and processing of data in SAP system.

The key components of the presentation layer include the following:

- **Message Server** – This is used to manage communication between distributed dispatchers in the ABAP system.

- **Message Server** – This is used to manage server processes and JAVA dispatchers. It is used to manage communication within JRE.
- **Dispatcher Queue** – This is used to store multiple work process types.
- **Dispatcher** – This is used to distribute the requests to the work processes.
- **Memory Pipes** – This is used to manage communication between ICM and ABAP work processes.
- **Enqueue Server** – This is used to handle logical locks set by the executed Java application program.
- **Java Dispatcher** – This is responsible to receive the client requests via presentation layer and forward to the server process.
- **Gateway** – This is used to manage communication between SAP system and external systems.
- **ABAP Work processes** – This separately executes dialog steps in R/3 applications separately.

End of ebook preview

If you liked what you saw...

Buy it from our store @ <https://store.tutorialspoint.com>